

# OUTLINE DIMENSIONAL DRAWING

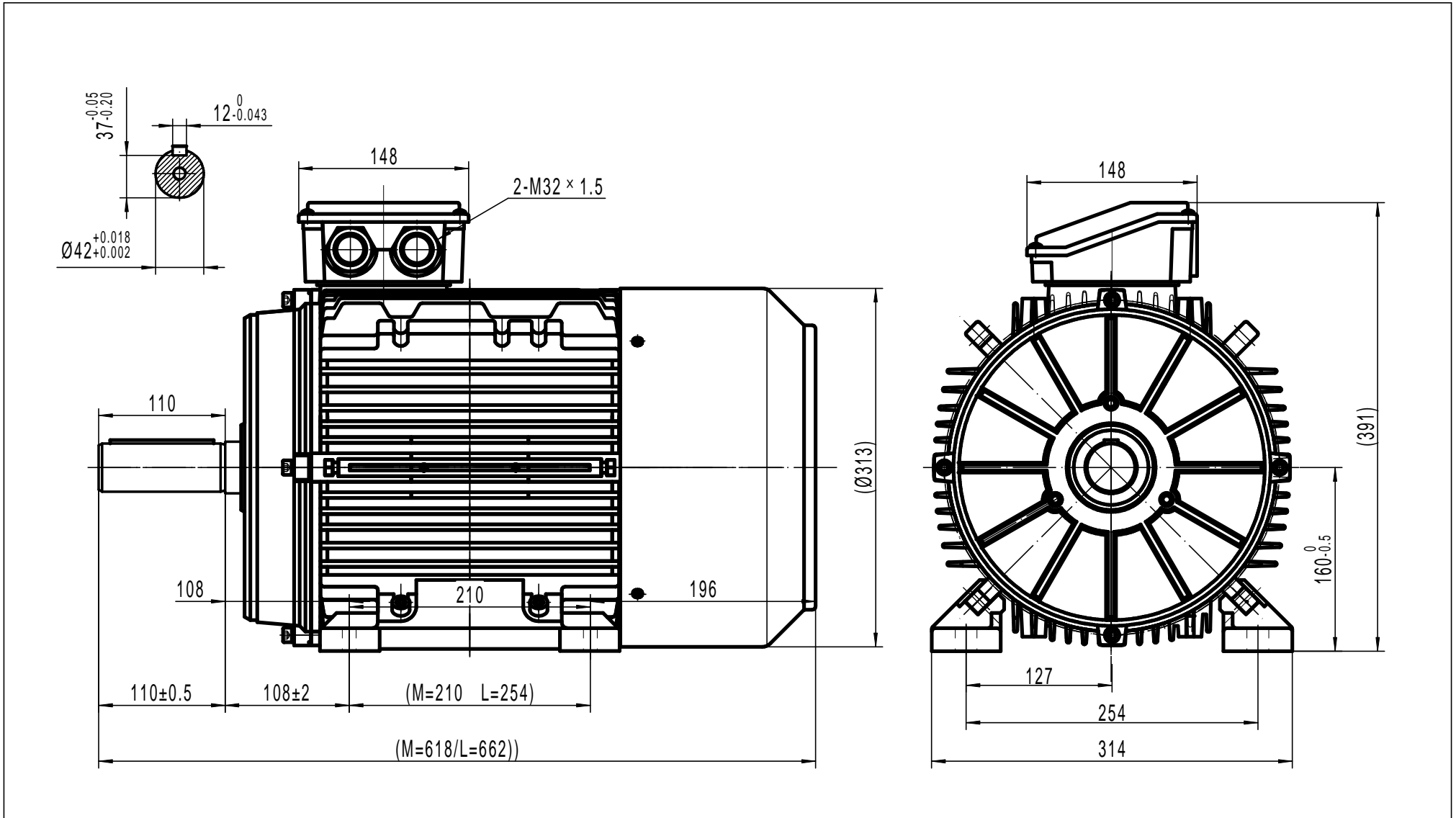

TECHTOP AUSTRALIA PTY LTD	
FRAME	TAI 160A B3
DATE	DRAWING NO.
2011/10/14	1ST087.050.001-032 A